

GREY
line

AC3 Series

Rack conveyor dishwashers

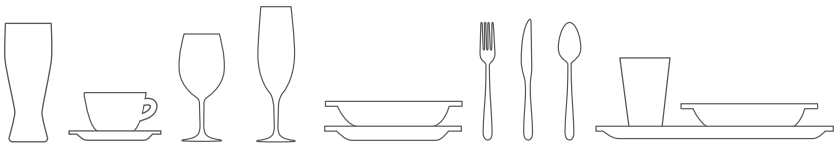

5 good reasons to choose the AC3 series

1 Economy

All COMENDA AC3 rack conveyor machines are factory-fitted with the MULTIRINSE rinsing system, which significantly reduces water, energy and chemical product consumption to achieve a significantly high standard of performance.

2 Hygiene

The pump, suction and drain pipework, washing columns and all hoses are located on the outside of the single-piece deep drawn tanks. The interior of the fully accessible enclosure is easy to clean and ensures maximum hygiene.

3 Performance

Thanks to the range of equipment and accessories available for the AC3, the “basic” model can be modified and perfectly adapted to the user’s requirements, regardless of the configuration and surface area of the premises.

4 Reliability

Simplicity of use and maintenance, combined with a rigorous selection of sturdy and reliable components supplied by leading European manufacturers, ensure the remarkable longevity of the Comenda AC3 under the most demanding operational conditions.

5 Quality

The Comenda AC3 series is manufactured in a European factory with ISO 9001:2008 quality and ISO 14001:2004 environmental certifications.



COMENDDA



ENVIRONMENTAL AWARENESS: A DRIVING FORCE FOR DEVELOPMENT

Respect for the environment is a core value for Comenda which has inspired the development of its product ranges and the management of the company since 1992.

With the ECO2 brand, Comenda's research and technological innovation efforts have achieved major results in the development of low environmental impact machines using less water, less product and less energy.

In 2011, its manufacturing plant was awarded the ISO 14001:2004 certification - a confirmation of the company's commitment to environmental responsibility.







AC3 SERIES

The range



COMPACT SOLUTIONS WITH CONSUMPTION REDUCED TO A MINIMUM

With the AC3 series, Comenda confirms its commitment to environmental responsibility and operational economy that inspire the ECO 2 philosophy by offering a state-of-the-art dishwashing system, in terms of both design and performance. Modularity is the core concept for the new series. Each machine consists of modules that can be assembled in a line or in a corner or double corner configuration, according to workload and space requirements. This feature, which is unique to Comenda, allows the dishwasher to be customised and the space to be optimised, simplifying the work of dishwasher operators.

CONSUMPTION IS REDUCED TO A MINIMUM, THANKS TO THE INNOVATIVE MULTIRINSE SYSTEM

This patented system allows just 100 litres of water to be used by having an active rinse area followed by a dripping area between the wash and ecorinse modules. When dishes reach the final rinse stage, they are less laden with detergent, which allows water, product and energy consumption to be reduced by 50%. The smart design of the wash system provides another benefit. Thanks to the direct suction placed at the lowest point of the tank, the effectiveness of the pump is increased, thus ensuring greater output and lower rated power. The position of the pumps, with their associated drain piping, on the outside of the tank, allows an outstanding standard of hygiene to be achieved, avoiding any build up of dirt in areas that are hidden or difficult to access for cleaning purposes.



MULTIRINSE

100 litres for 200 racks/hour

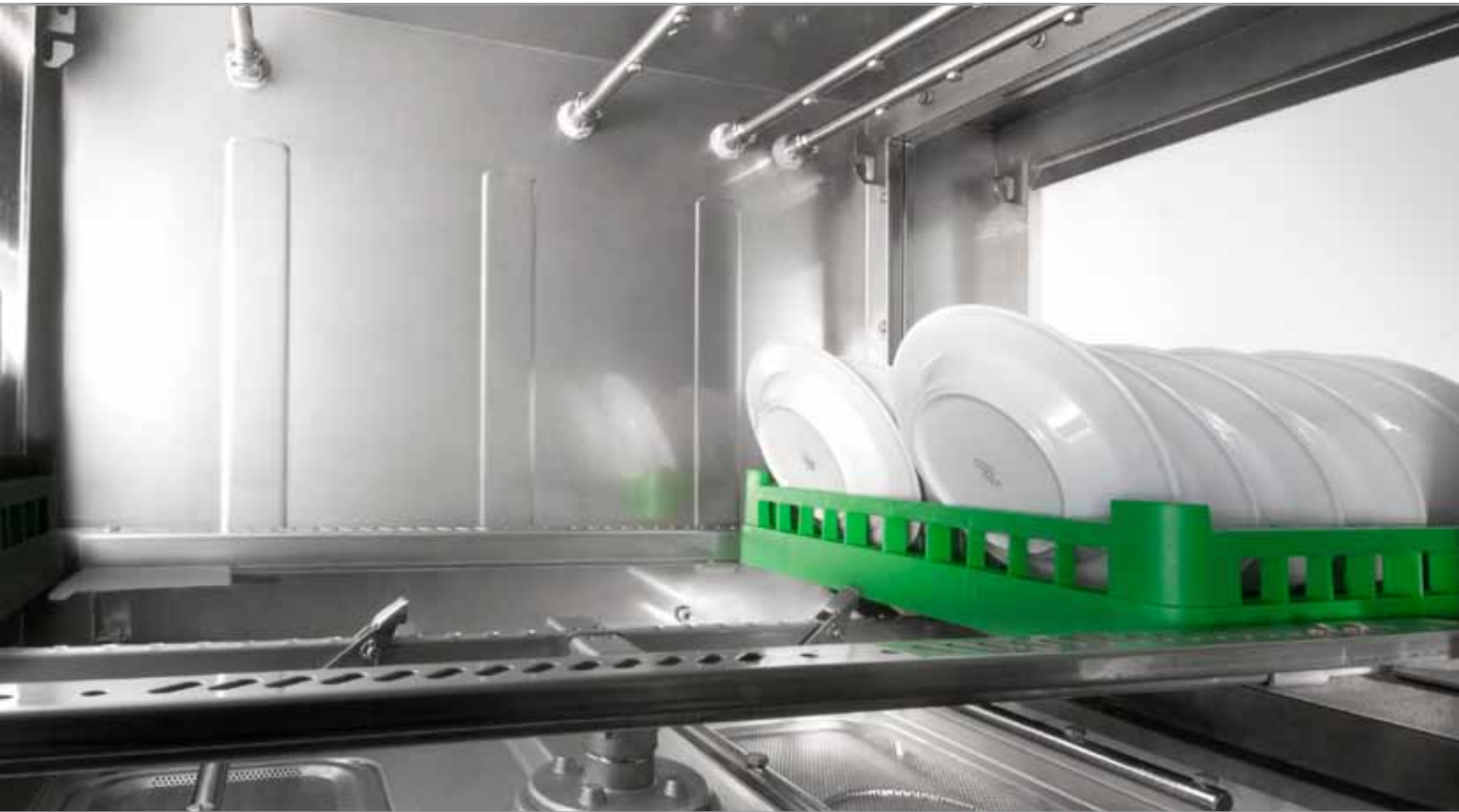

WITH ITS NEW AND EXCLUSIVE “MULTIRINSE” SYSTEM, COMENDA ACHIEVES A 50% SAVING ON RINSE WATER CONSUMPTION

The exceptional and easily verifiable performance of the new patent registered by COMENDA in the state-of-the-art “MULTIRINSE” system truly and dramatically reduces rinse water consumption in the new COMENDA AC3 rack conveyor machines.

The key function of the first pump-activated rinse is to present dishes for the Ecorinse Plus stage that are virtually free of detergent. As a result, the final high temperature rinse with rinse aid virtually becomes a polish and hygiene stage.

“MULTIRINSE” guarantees an impeccable result with just 0.5 litres of water per rack, which corresponds on average to a 50% reduction compared to other 200 racks/hour machines. This exceptional water saving is accompanied by a proportional reduction in installed capacity, energy consumption, detergent and rinse aid.

With “MULTIRINSE”, the new COMENDA AC3 machines provide the lowest operating cost ever achieved.

1st ACTIVE RINSE



DROP DOWN



ECORINSE+



FINAL RINSE





PRE-WASH SYSTEMS

Waste recovery



P6 AND DHM PRE-WASH AREAS

Waste management guidelines encourage maximum waste recovery for the purpose of processing and reuse and require discharges of greasy water to be significantly reduced.

THE PRE-WASH P6 DESIGNED BY COMENDA HAS THIS EFFECT

The waste removed in the pre-wash area is collected in a cassette filter, which can be taken out for cleaning, even during washing operations, without stopping the machine.

A second filter positioned directly above the pre-wash tank stops the dirt falling back into the tank during this operation.

A third filter is in any case located on the pump suction in order to protect it.

DHM ADDITIONAL PREWASH

The DHM Additional Prewash by Comenda is an innovative pre-scrapper zone. The combination of arms with three different types of jets which independently eliminate a large part of food residue found on the dishware avoids soil build-up in next wash module

Installed as the first module in the dishwasher in addition to the traditional prewashing area, the DHM effectively replaces the manual prewash usually done with a sprayhose, the main source of water consumption in dish washing areas.

The DHM works as a closed circuit. The tank is constantly fed by the overflow from the adjacent prewash tank, in addition to supplying clean water at a programmable frequency and duration. Plus, this regenerated water is sent to the tank using a specially inclined jet that helps clean the filter, pushing the impurities in the filter to the adjacent drawer.

Like all prewash modules for this range of dishwashers, the DHM also has an inspection door as well as a triple filter system including a removable drawer filter that can be emptied without interrupting machine operation.

The DHM optimizes overall wash results, however adequate preparation and correct positioning of the dishes in their racks is always necessary.



PWS®

A revolutionary washing process

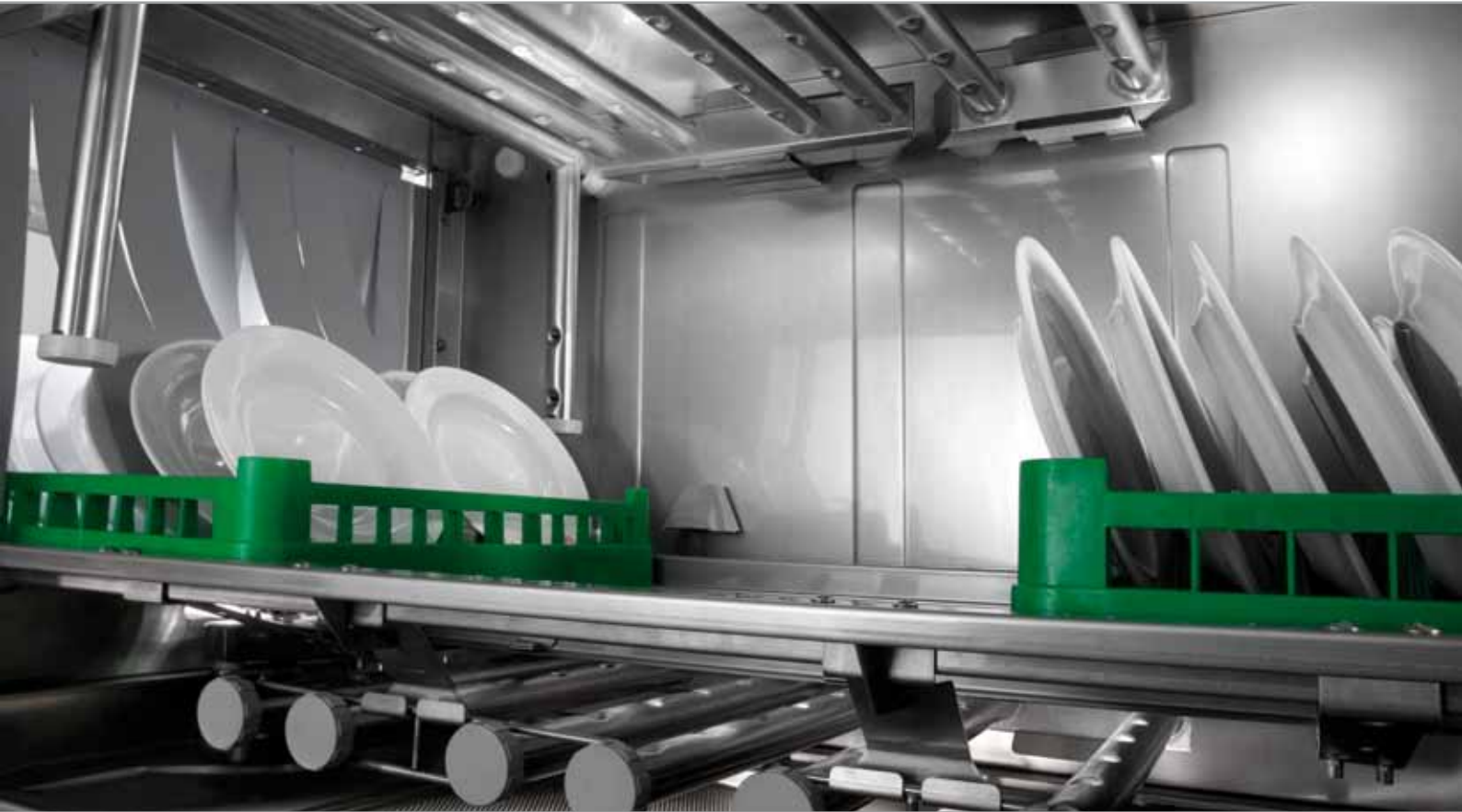

PROPORTIONAL WASH SYSTEM: A NEW CONCEPT OF INNOVATIVE HIGH-PERFORMANCE CLEANING

Developed for the AC3 series, the new PWS modulates the flow rate and volume of water according to the selected wash speed. Ideal for all types of dishes, this system features three different speeds, optimizing consumption and customizing the work shifts.

76 JETS FOR A THOROUGH AND INTENSIVE CLEANING

Thanks to the Proportional Wash System, the operator can select the second speed, in accordance with DIN 10510 norms, or the fastest speed, increasing the contact time between the water and the dishes. Selecting either of these two options, twelve washing arms are activated - six upper and six lower - to which two on the sides are added. 76 jets in total operating on an exceptionally long washing area: 115 cm. The result is an accurate and effective cleaning.

GREATER PRESSURE FOR A MORE EFFECTIVE CLEANING

For heavy soiled dishes, or for washing large objects such as GN1/1 trays, the operator may instead select the slower advancement speed. 48 jets operating, spread out over eight arms - four upper and four lower - plus four side jets. The mechanical action is therefore concentrated in a limited space, but takes advantage of the high water pressure. It is possible, therefore, to remove dirt more vigorously and obtain a neutral drip zone that prevents the pouring of water into contiguous zones. An effective and versatile solution: in the event that intensive action is needed, all 76 jets can still be activated with the touch of a button.



FEATURES and details



WASH SYSTEM

Stainless steel upper and lower washing manifolds with negative embossed anti-drip nozzles and inspection cap.



DRIVE SYSTEM

Central drive system with side rack supports. This system allows better handling of the racks, preventing their deformation and ensuring smooth rack transport without deviations.



TANK FILTERS

Complete coverage of the tank with stainless steel filters plus pump suction safety filter.



INSULATION

Thanks to the thickness of the door, the insulation is particularly efficient - energy dispersal and noise levels are in fact significantly reduced.



DOOR WIPE SEAL

The special shape of the seal allows the door to be cleaned automatically when opening and closing.

DOOR INTERIOR

The inspection doors with integral balancing springs have smooth and hygienic surfaces.

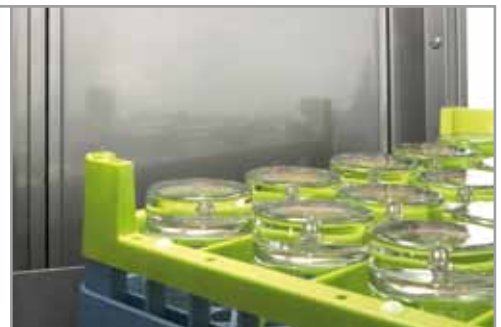

SAFETY HOOKS

Integral hooks inside the runners ensure secure hooking of the door and ease of operation.



TECH + HPS EASY

New control panel



The HPS Easy constantly monitors the machine main operation data and displays, Total & Partial essential information on screen:

- Rinse water consumption in m³ and litres
- Electricity consumption in kWh
- "On" time in h
- Operation time in h
- Rinse time in h

TECH CONTROL PANEL

AC3 machines are fitted with a TECH panel with simple and easy-to-use controls. Electronmechanical operation and digital temperature readout. It is so simple to use that the AC3 can be operated by untrained staff. In order to allow the advertised performance to be verified, AC3 machines are equipped with HPS EASY, a simple system developed by Comenda to allow the operator to monitor consumption using the readings permanently displayed on the screen without the use of any software.

HPS EASY

This modular system includes an electricity meter, a rinse water volume meter, operational anomaly display and a user interface consisting of a bright LCD screen and two buttons. HPS Easy monitors the operation of the machine and displays the following information on screen: machine on, machine ready and machine operating. Checking each diagnostic signal against the reference parameters, for each machine, the system activates a visual alarm whenever an operational anomaly arises. HPS Easy keeps track of the various alarms and records those that have repetitive causes.

ELECTRONIC 4

Touch Technology

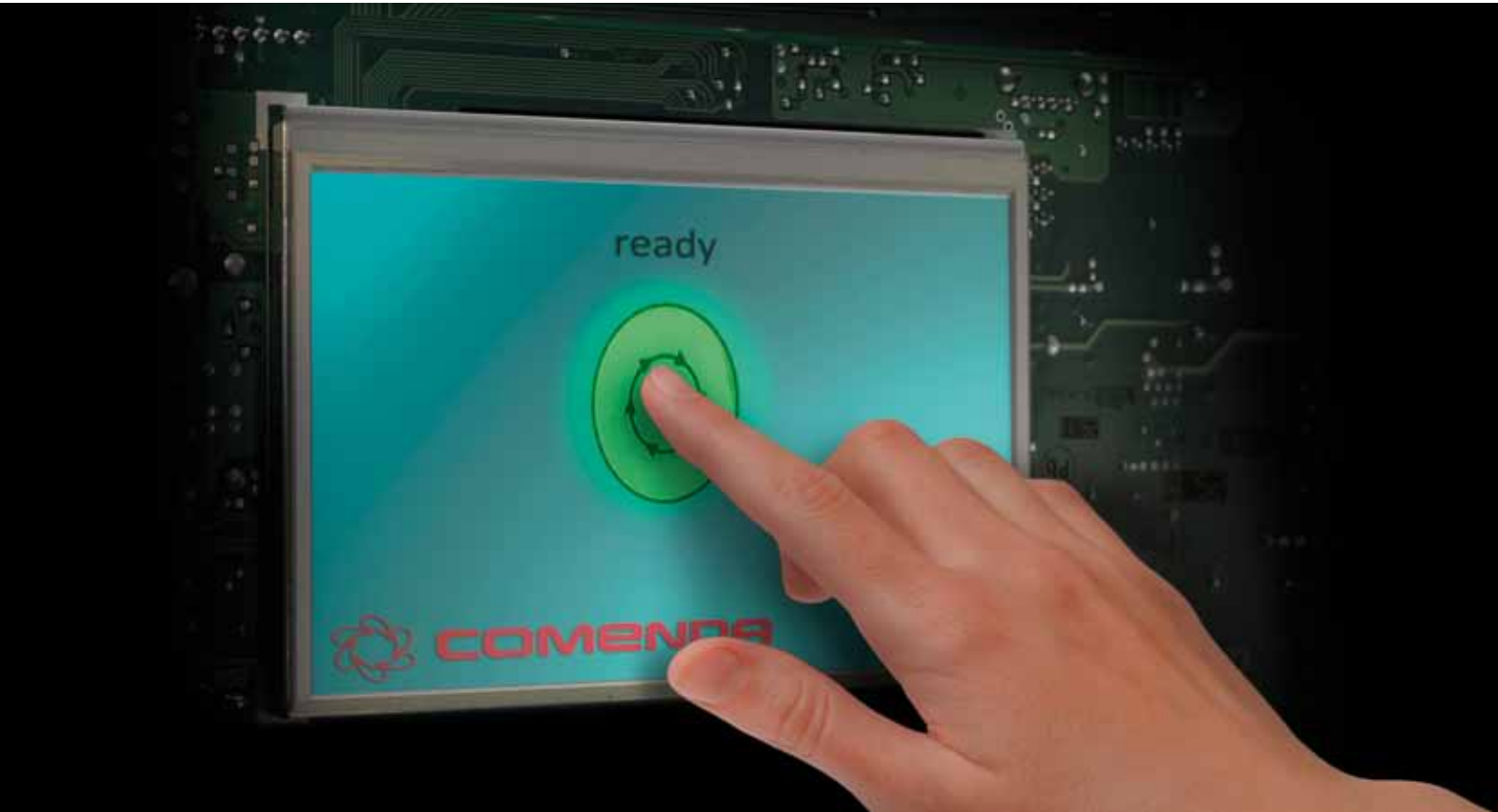

THE TECHNOLOGICAL HEART OF PROFESSIONAL CLEANING

The new AC3 dishwashers provide the best technology in order to ensure an excellent real time connection between user and machine. The E4 screen provides remote communication with the machines and allows data to be downloaded in real time, from any location, so that anomalies can be detected and operating parameters modified.

Extreme ease of use. All you need is a PC, a mobile phone and a USB stick or memory card.

Two levels menu. Operator access can be restricted to a few specific parameters. Engineers or washing area managers can access menu customisation functions. The screen allows operational data to be collected in order to draw up the HACCP protocol.

Straightforward user interface - with the help of the bright TFT LCD colour display, the touchscreen technology allows the devices to be used in any lighting conditions.



ARC Triple effect dryer with integrated heat recovery unit

THE NEW ARC SYSTEM ALLOWS THE HOT AND HUMID AIR FLOW CREATED INSIDE THE MACHINE TO BE UTILISED.

FIRST EFFECT

Dehumidification of the air in the machine - the recovery unit removes the hot and humid air, passing it through the condenser battery, where cold water runs in the opposite direction, thus creating the following two effects: the humid air condenses inside the battery and is not released into the washing area; the cold water recovers the heat from the air and warms up before being fed into the heater, allowing a substantial saving on heating power. Furthermore, this suction and recovery area, located in the hottest section of the machine (between Multirinse and drying), increases the effectiveness of this initial action.

SECOND EFFECT

Managing the evaporation of hot air from the dishes - the recovery unit contributes to drying the dishes by removing the hot and humid air produced by evaporation of the water remaining on the dishes.

THIRD EFFECT

Blowing of hot air - by using dehumidified air, the power of the drying tunnel heaters can be significantly reduced. The drying fan recycles some of the hot air passing through the heaters, increasing its temperature while reducing its humidity. The Comenda ARC system provides this correct balance between the air removed by the recovery unit and blown by the fan. The volume of air extracted by the machine is therefore dramatically reduced compared to conventional models.

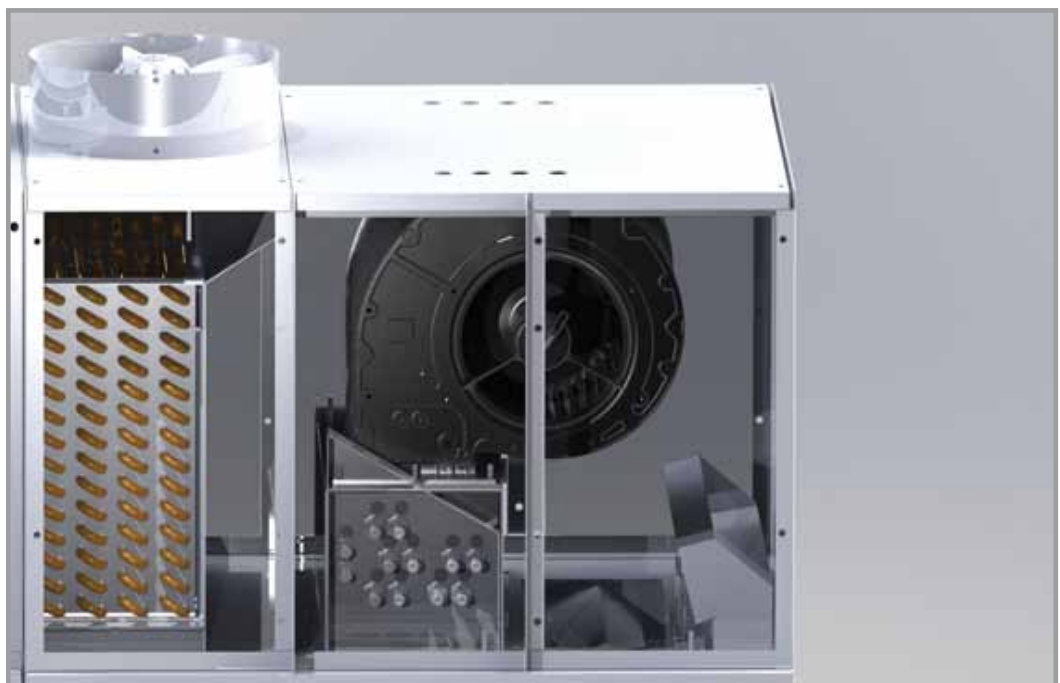



WP Heat pump



ENERGY SAVING AND A HEALTHIER ENVIRONMENT

CONNECTION TO THE EXTRACTION SYSTEM IS NO LONGER REQUIRED.

Specifically designed for AC3 rack conveyor machines, the dual effect WP7 heat pump allows savings of up to 40% to be achieved in the energy normally used to heat the water.

The system's capacity to absorb the heat produced by the machine considerably reduces the latent heat because the extracted, cooled and dehumidified air is released directly into the premises according to VDI 2052 specifications, creating excellent working conditions in the washing area.

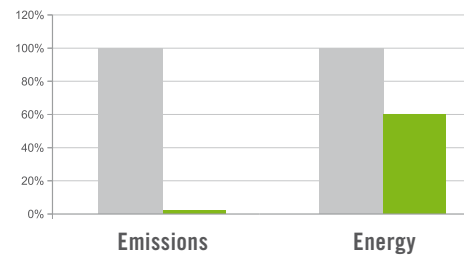

	Emissions	Energy
STD standard	100%	100%
+ WP	2%	60%

APP & WEB

Online support



THE APP

State-of-the-art technology brings support services up-to-date - available on AC3 dishwashers, the new tools allow engineers to interact with the company in real time and provide a quick and effective after-sales service.



Developed for Android and Apple, the app can be installed on any mobile device and smartphone. From a digital tablet or mobile phone, it provides access to the Comenda website's private area to check catalogues, instruction manuals and exploded diagrams of the product, quickly allowing orders to be placed for spare parts.



QR CODE

Each machine is identified by a specific QR code - a dishwasher identity card that provides access to all the technical documentation and allows supplies of spare parts to be managed electronically.



SUPPORT AT THE TOUCH OF A MOUSE

Faithful to its corporate philosophy, Comenda offers both excellent products and an all round support service. In order to provide its customers with the best possible real time support, along with its national and international network of qualified technicians, Comenda provides an easy-to-use online tool. The www.comenda.eu website includes a section which currently has over 700 registered users and provides support and an online parts ordering system. Engineers can access the website using their own password and consult or download exploded diagrams and electrical, hydraulic and installation diagrams. With a few clicks, installers can access the user manual for all new machines, as well as all machines produced over the past 20 years, and automatically send error-free orders directly to their national spare parts office.



LESS CHEMICALS

Less use of detergents

Consumption reduced by up to 33%

PRS and APRS

Despite being able to operate at different speeds, conventional rack conveyor dishwashers always use the same amount of rinse water, which causes an enormous amount of waste.

Patented PRS (Proportional Rinse System) systems and their automatic version APRS, which can be incorporated in this range of dishwashers, are a real revolution in this sector as they allow the amount of water to be adapted accurately to the load placed in the machine and the rack travel speed selected, thus reducing water, energy and chemical product consumption by up to 33%.

Rinse aid reduced by up to 70%

RAH – Rinse aid homogeniser (patented)

Rinse aid has a greater density than water. The two substances cannot mix uniformly, meaning that more rinse aid has to be used in order to achieve good drying results. The optional RAH system, designed to help combine two liquids of differing densities, is the ideal solution to this problem as it reduces the amount of rinse aid required by up to 70%, consequently saving money and reducing the environmental impact.

SPEED I and II = A
SPEED III = A + B

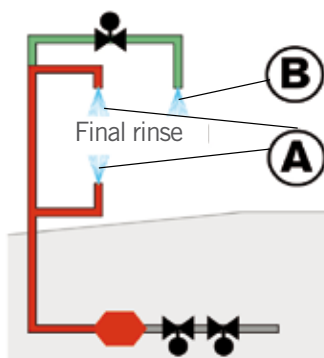

PRS and APRS technical explanation

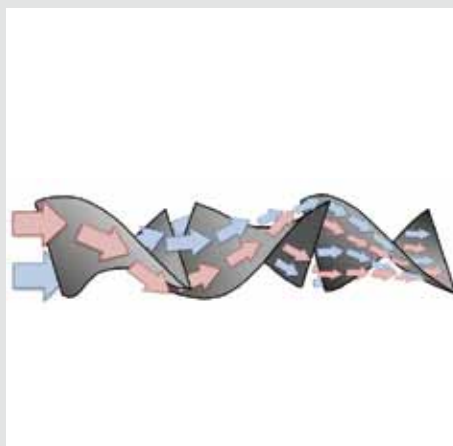

RAH Mixing of two liquids



THE RANGE

Dimensions

AC3-20

122/135/182 racks/h

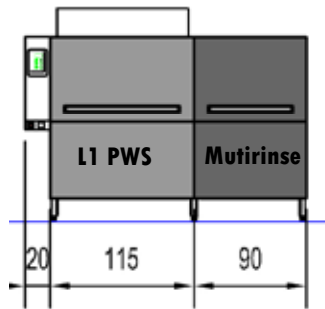

AC3-35

203/225/304 racks/h

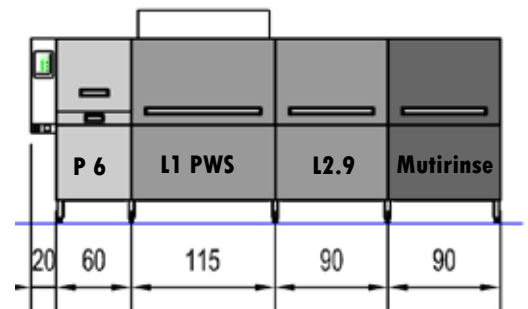

AC3-25

153/170/230 racks/h

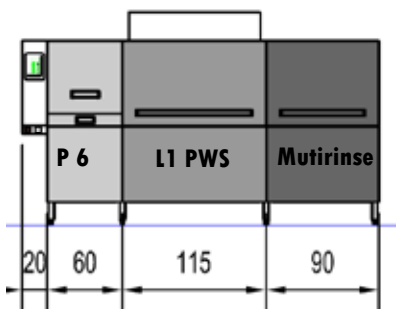

AC3-40

216/240/324 racks/h

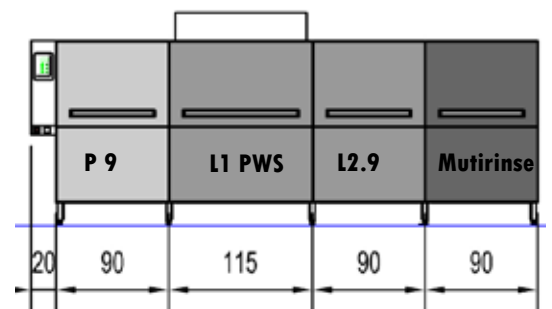

AC3-30

171/190/257 racks/h

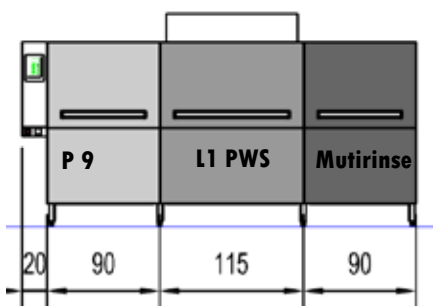

AC3-45

234/260/351 racks/h

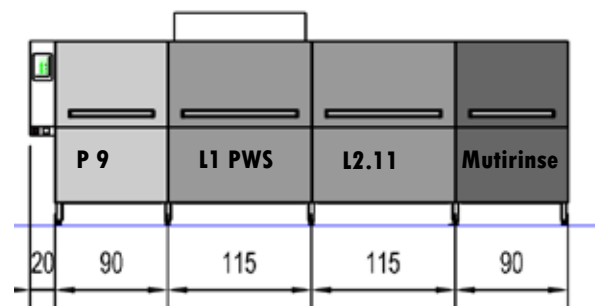

MODULARITY

Space management

PREWASH (PR) AND WASH AREA (L) OPTIONS

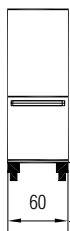

DHM

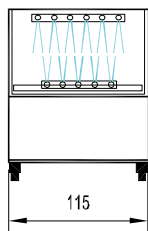

PR11

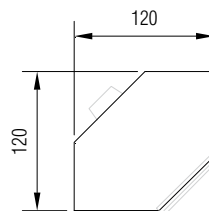

PR11.A

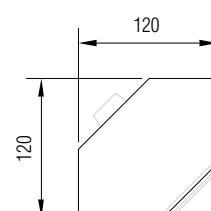

L11.A

MULTIRINSE OPTIONS

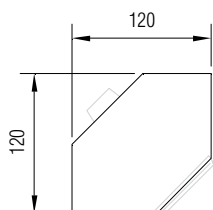

DRYING TUNNEL OPTIONS

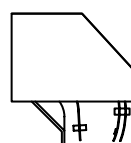

TC90

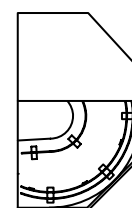

TC180

TECHNICAL DATA

AC3 SERIES	AC3-20	AC3-25	AC3-30	AC3-35	AC3-40	AC3-45
Rack production per hour with 2 minutes of contact time according to DIN10510 (speed II)	135	170	190	225	240	260
Maximum rack production per hour (speed III)	182	230	257	304	324	351
Production on speed I (intensive wash)	122	153	171	203	216	234
Total length of machine without dryer (mm)	2250	2850	3150	3750	4050	4300
Tank capacity (L)	108	148	188	228	268	268
Rinse water consumption per rack (L in continuous use)	0,5	0,5	0,5	0,5	0,5	0,5
Power supply	400V 3N 50Hz	400V 3N 50Hz	400V 3N 50Hz	400V 3N 50Hz	400V 3N 50Hz	400V 3N 50Hz
Installed power with AS and WP (cold water feed at 15°C) kW	20,29*	22,12*	22,4*	29,48**	31,32**	32,22**
Average power consumption (kWh)	13,78	16,52	17,23	24,43	25,15	26,56

* WP7

** WP8

We reserve the right to modify technical features and pictures.

COMENDA



Certified Company



COMENDA

the environmentally friendly brand



COMENDA Ali S.p.A. Via Galileo Galilei, 8 - 20060 - Cassina de' Pecchi Milano - Italy
T +39 02 95228.1 - F + 39 02 9521510 - sales@comenda.eu www.comenda.eu

cod. 900912EN/03-14